

REV.	DESCRIPTION	APPROVED	DATE
A	INITIAL RELEASE	L.H.L	2018/04/21
B	E0180812	L.H.L	2018/08/09
C	E0180839	L.H.L	2018/08/30

- 1 MATERIAL: BRASS
- FINISH: NI-PLATED
- 2 MATING TAB: 4.8X0.8
- 3 WIRE RANGE: 22-18AWG , 0.5-1.0mm²
- INSULATION RANGE: ϕ 2.0- ϕ 2.8
- 4 CONTINUOUS STRIP ON REELS.
- 5 PARTS ARE ROHS COMPLIANT.

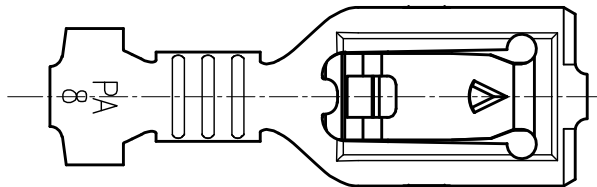
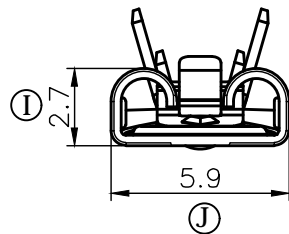
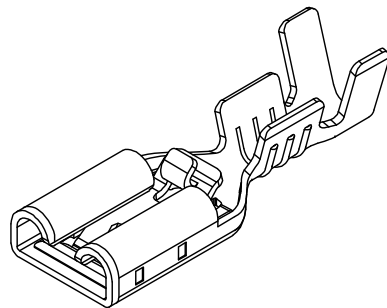
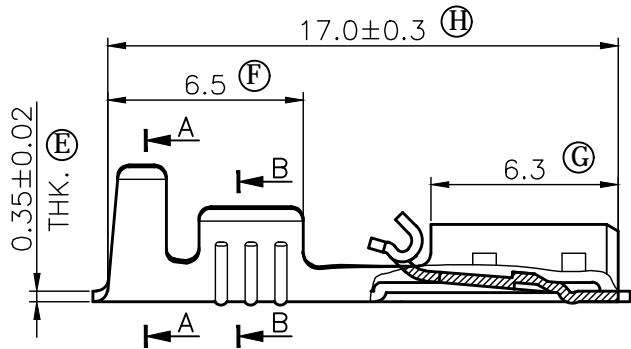
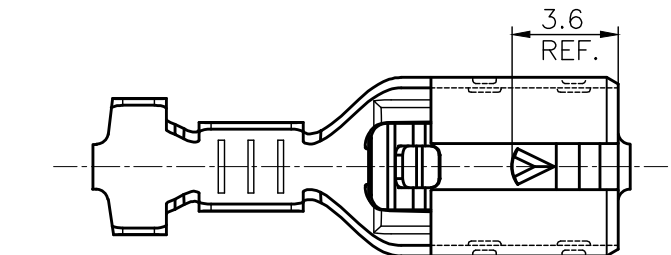
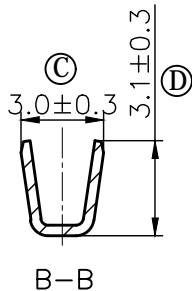
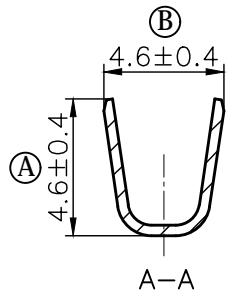

CUSTOMER DRAWING	TITLE .187 LOCK-IN RECEPTACLES	MODEL NO.: LK1870804	DWN: L.H.L	2018/08/30	
		DWG NO. : CD-LK187-003	REV.: C	CHK: C.H.P	2018/08/30
GENERAL TOLERANCES (UNLESS SPECIFIED) .X ±0.2 .XX ±0.05 .XXX ±0.01 A' ±2'		UNIT: mm	SCALE: 4:1	APP:	力幹企業有限公司 POWER ACT ENTERPRISE LIMITED